

# OWNER MANUAL

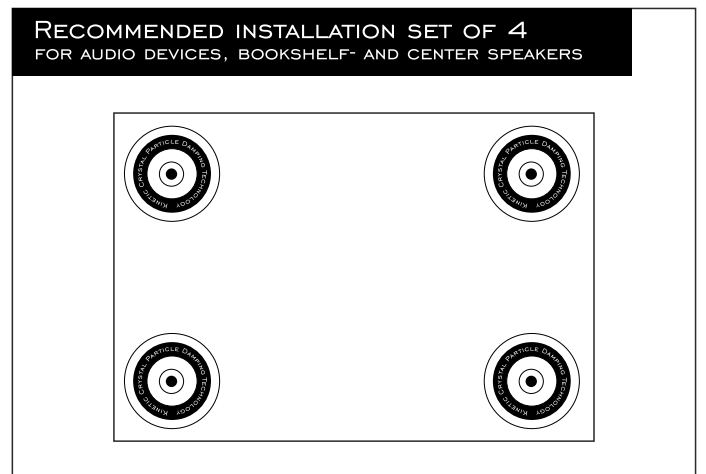

## CRYSTAL PARTICLE DAMPING TECHNOLOGY VIBRATION CONTROL SYSTEM

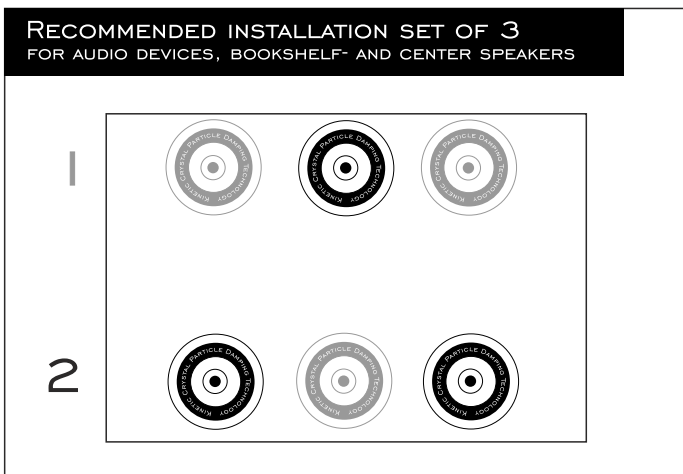
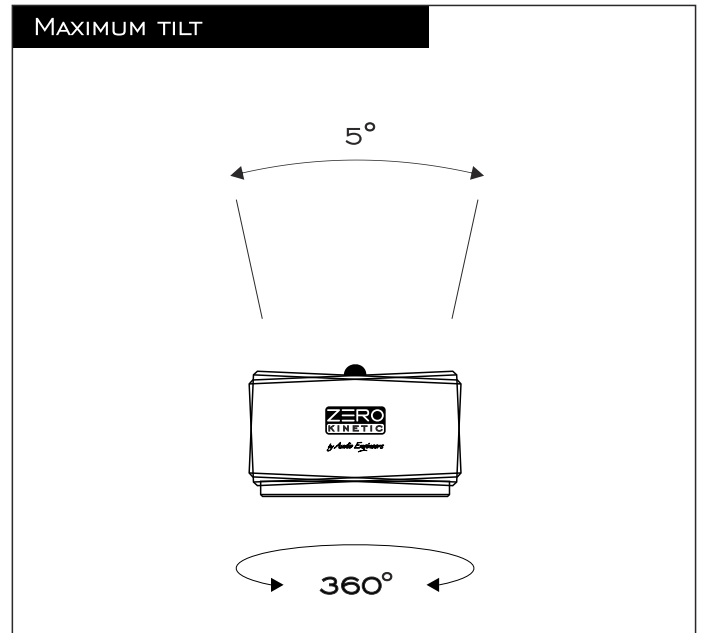
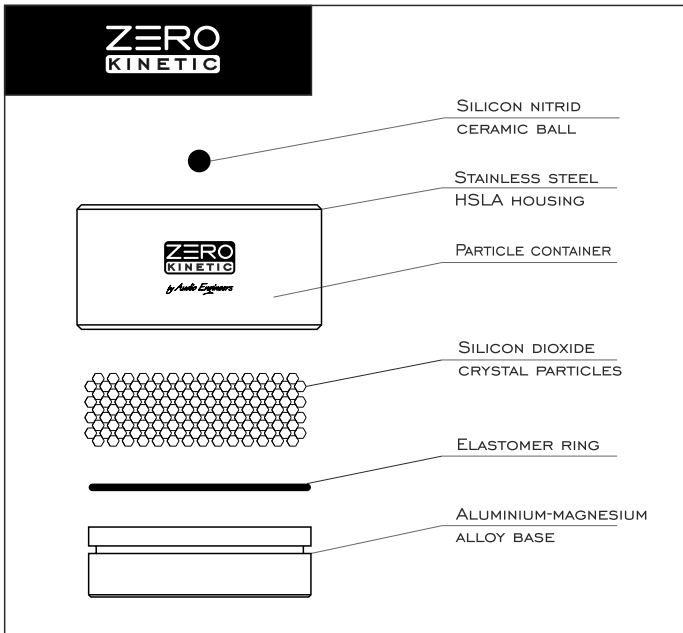
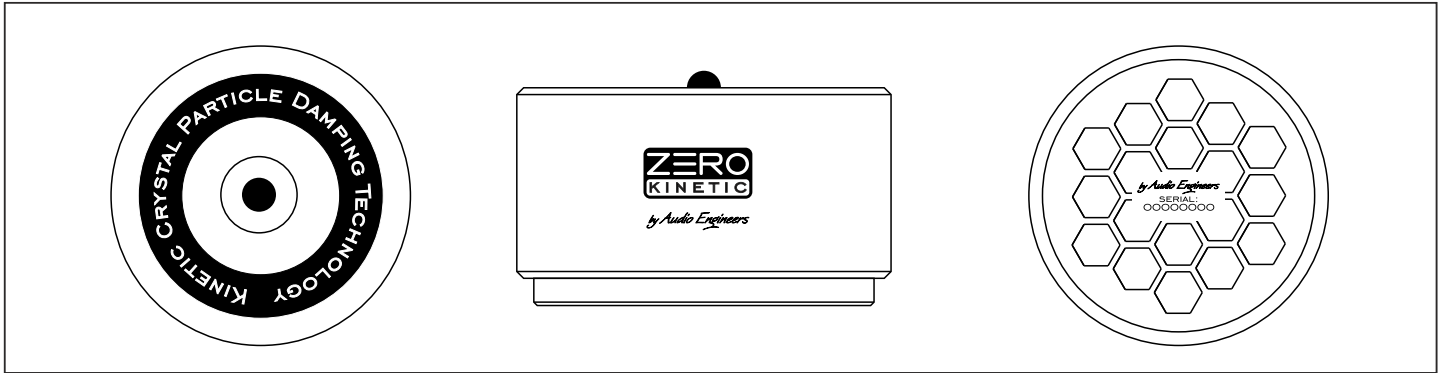

**RECOMMENDED INSTALATIONS WITH CERAMIC BALL**  
FOR AUDIO DEVICES, BOOKSHELF- AND CENTER SPEAKERS

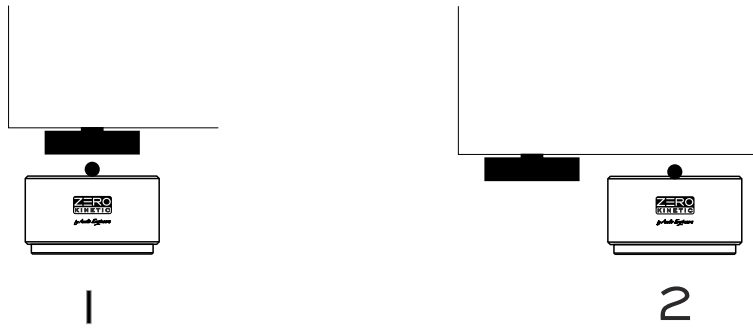

**RECOMMENDED INSTALLATION SET OF 4**  
FOR FLOOR STAND SPEAKERS, STANDS AND MEDIA FURNITURE

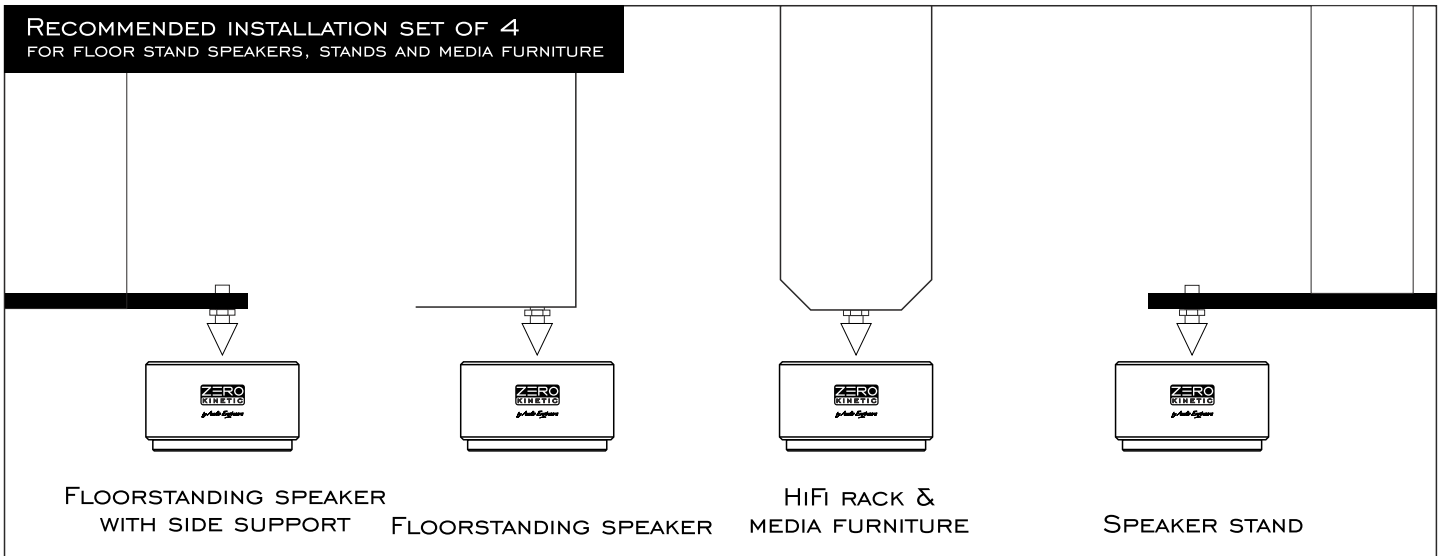

FLOORSTANDING SPEAKER  
WITH SIDE SUPPORT

FLOORSTANDING SPEAKER

HiFi RACK &  
MEDIA FURNITURE

SPEAKER STAND

**RECOMMENDED INSTALLATION SET OF 4**  
FOR FLOOR STAND SPEAKERS, STANDS AND MEDIA FURNITURE

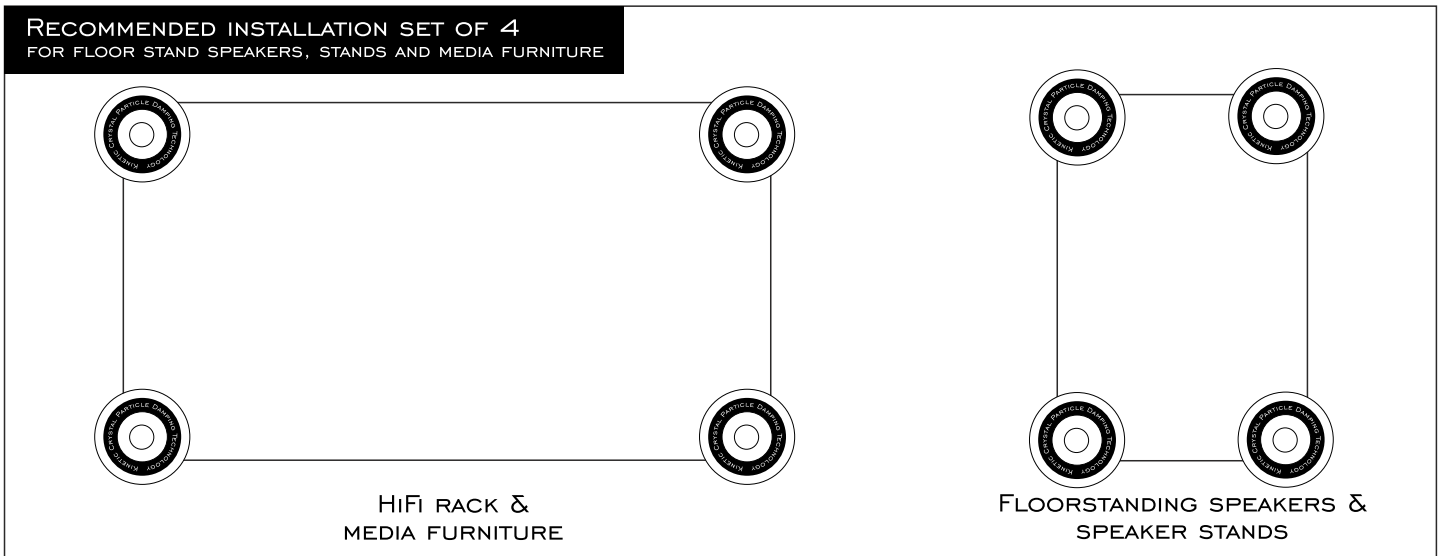

HiFi RACK &  
MEDIA FURNITURE

FLOORSTANDING SPEAKERS &  
SPEAKER STANDS

DESIGNED AND ENGINEERED IN THE UK.  
MADE WITH PRECISION HAND ASSEMBLY IN THE EU.

**SPECIFICATION:**

**COLOR:** STEEL GRAY SHINE  
**MATERIALS:** STAINLESS STEEL HSLA, ALUMINIUM-MAGNESIUM ALLOY,  
SILICON NITRIDE CERAMIC, SILICON DIOXIDE CRYSTAL GRAINS, ELASTOMER  
**DIMENSIONS:** 2,2" x 1,1" / 55 x 28 MM  
2,2" x 1,25 / 55 x 31,5 MM WITH CERAMIC BALL

**PARTICLE**

**HARDNESS:** MOHS 7.0  
**WEIGHT:** 0,55 LBS / 250 G / 1 PC  
**LOAD CAPACITY:** 200 LBS / 90 Kg / 1 PC

WWW.AUDIOENGINEERS.EU



DESIGNED &  
ENGINEERED  
IN THE UK

by Audio Engineers